



T A C C I I A



T A C C I I a

Since its introduction in 1978, the TACC (Timed Access Cash Controller) from Tidel has become the standard for deterring robbery and improving cash handling processes for retail locations in over 50 countries worldwide. The Industry-leading TACC IIa continues that legacy today by providing a simple, user-friendly interface, easy-to-use cash dispensing and receipt drop operations, and high reliability all in a cost effective solution. The TACC IIa minimizes everyday accounting burdens - allowing your managers and employees to spend more time with customers and less time managing money.

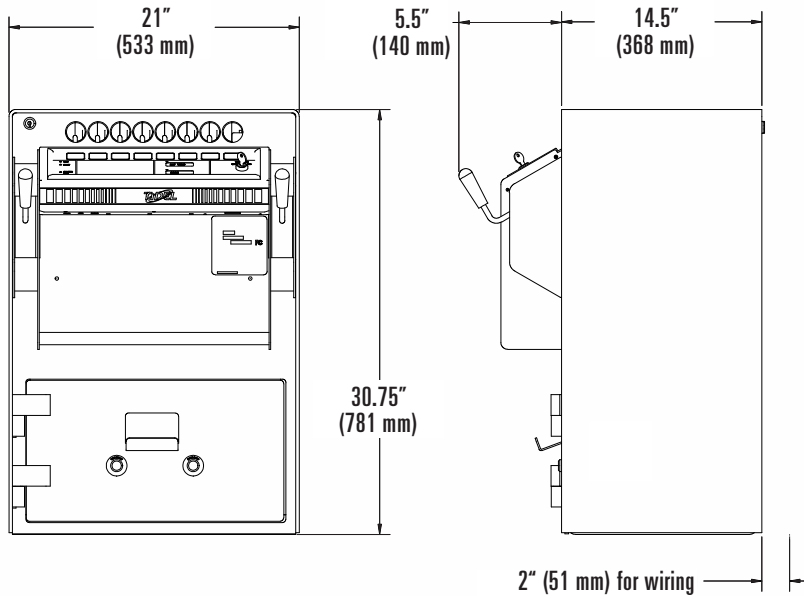

SPECIFICATIONS:

Weight: 290 lbs. (132 kg)

Power Requirements:
120 VAC 60Hz or 220 VAC 50Hz

Power Connections:
Unit must be connected to a dedicated power circuit consisting of "line", "neutral" and "ground" leads or connected to the optional Tidel surge protector.

FEATURES:

- 1/4 Inch Powder Coated Steel Plate Body and Door
- Medeco Key Locks
- Internal Floor Anchors
- Dual Anti-Fish Drop Chutes to the Storage Vault
- Electronic Time-Delayed Change Fund Vending (Stores up to 88 Tubes)
- Alternate Vending Delay Time
- Integral Vend-Tube Locking Bar
- RoHS Lead-Free Compliant

OPTIONS:

- Armored Car Instant Access Key
- Custom Colors Available

WARRANTY:

- 24 Months Parts and Labor Warranty (USA/Canada)
- 24 Months Parts Warranty Outside North America

